

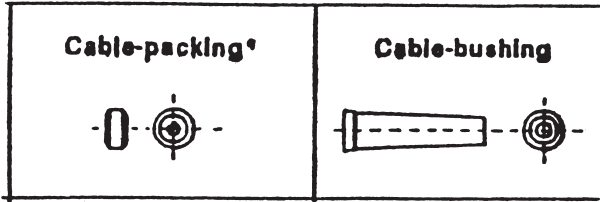

P.O. Box 519	1351 W. Second Street	379 Davis Road, Unit #3
Córona, California 92878-0519	Oconomowoc, Wisconsin 53066	Oakville, Ontario, Canada L6J 2X2
Phone: 909-735-8220; 800-543-3885; 800-735-1922	Phone: 262-567-2288	Phone: 905-844-1791; 800-361-9473
Fax: 909-735-2372; 800-752-6001; 800-735-0857	Fax: 262-567-0857	Fax: 905-844-2583; 800-663-0933

PPS PENDANT STATIONS

ASSEMBLY INFORMATION



CAUTION

MAKE CERTAIN POWER SUPPLY IS DISCONNECTED BEFORE INSTALLING, REPAIRING, OR WORKING IN THE PROXIMITY OF ANY ELECTRICAL SYSTEM. ONLY QUALIFIED ELECTRICAL PERSONNEL SHOULD INSTALL OR REPAIR THESE PRODUCTS.

Two sizes of cable packing are supplied with each enclosure. Cut them apart and install the one which matches the diameter of the cable used.

Install the cable packing in the ring holder right below the cable bushing.

Enclosure Openings

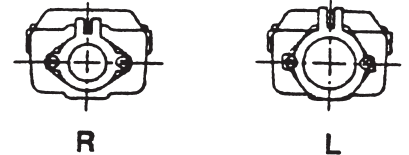

3R, 4R, 5R, 6R 3L, 4L, 5L, 6L

R - For DOW 12 Conductor Cable
 L - For DOW 16-24 Cond. Cable
 XL - For 1.125" Dia. Cable (Request)

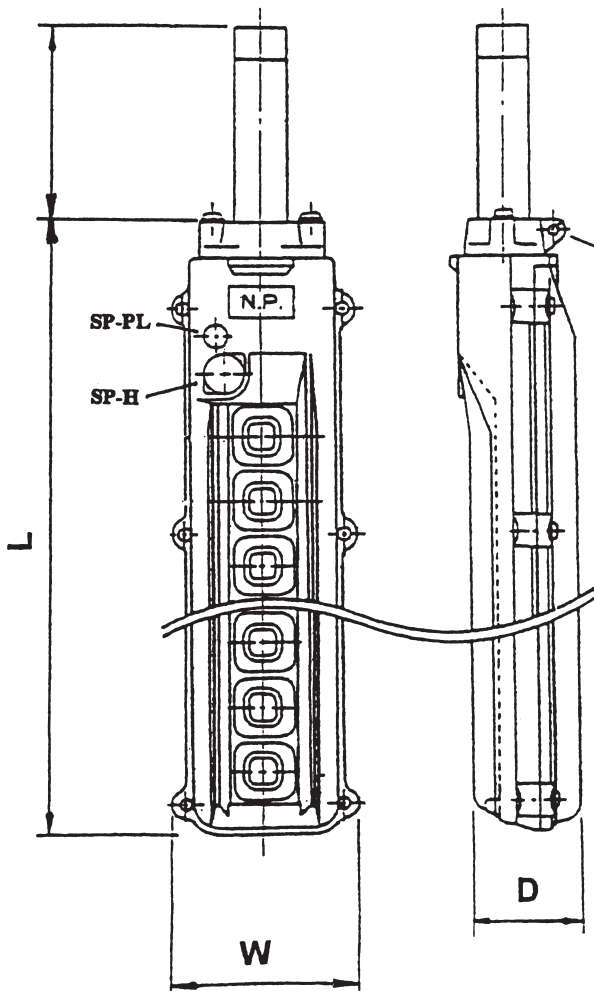

The cable packing and hook assembly are packed in reverse for boxing. Rotate 180 degrees upon assembly so the hook is on the face side for use.

NOTE: The SP-PL & SP-H small pilot and horn button openings are only available on the 6 to 12 hole enclosures.

ENCLOSURES

Catalog Number	Enclosure Type	Dimension - Inches			Weight Lbs.	Accommodates Cable Diameter - Inches
		Width	Depth	Length		
PC-1	Two-Button	3.125	1.875	5.25	1/2	.412-.540
PC-2	Four-Button	3.125	1.875	7.75	3/4	.532-.660
PC-3	Six-Button	3.125	1.875	11.125	1	.532-.660
PC-4	Eight-Button	3.125	1.875	13.125	1-1/2	.552-.780
PC-5	Ten-Button	3.125	1.875	16	1-3/4	.552-.780
PC-6	Twelve-Button	3.125	1.875	18-1/4	2	.760-.886
FT-3	Six-Button	3.125	2.750	11.25	1-1/4	.523-.660
FT-4	Eight-Button	3.125	2.750	13.125	1-3/4	.552-.780
FT-5	Ten-Button	3.125	2.750	16	2	.552-.780
FT-6	Twelve-Button	3.125	2.750	18.250	2-1/4	.760-.886

Specify Cable Diameter When The Cable Used Is Not Within The Range Listed
 Each Enclosure Includes a Legend Plate Sheet, Neoprene Cord Grip, Strain Relief Attachment, and Neoprene Boots

Included with each PPS enclosure is a set of clear plastic button covers, a button cover legend plate set, and a vertical legend plate set. The illustration on the lower right will aid in locating the desired legends. Shown below are all of the legend words.

The button cover legends are placed on the rear of the clear plastic button cover. Take care that the legend is centered on the button cover. Then with a blunt pointed tool such as a pocket screw driver or a stylus, position the button cover into the rubber boot. See illustration at the right.

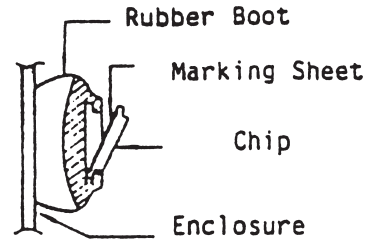

BUTTON LEGENDS

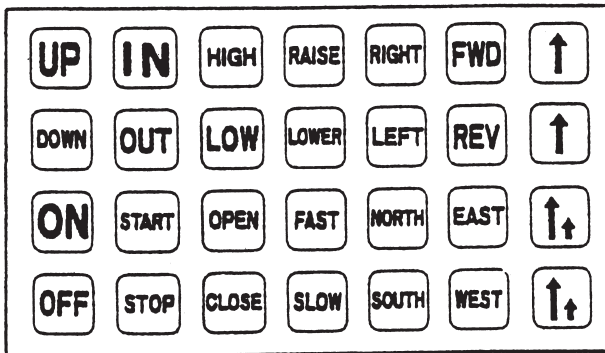

VERTICAL LEGENDS

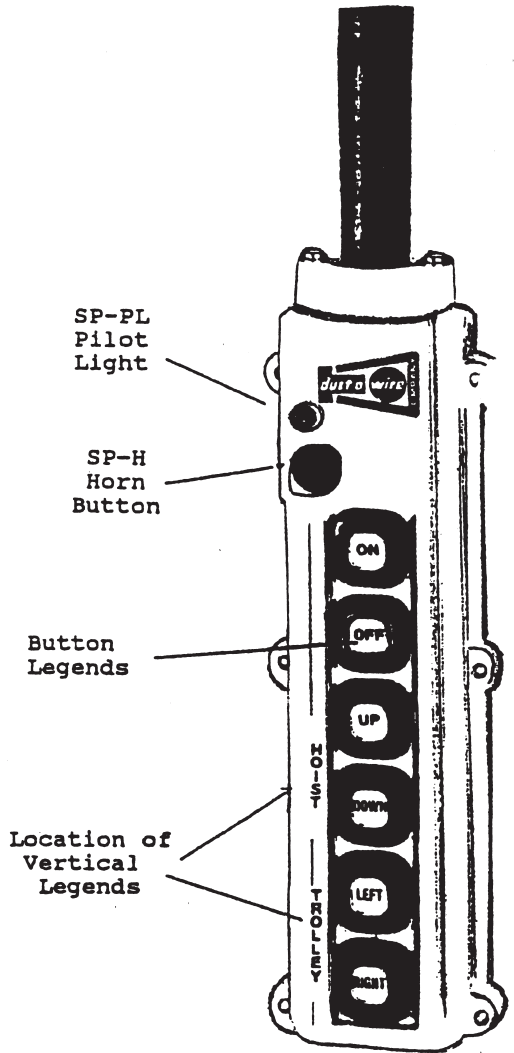
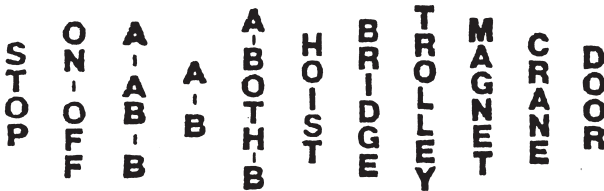

Applicable Range Of RPC Cable	Bushing Type	Cable-Packing	Cable-bushing
.295" - .413"	COB A1	CC-A1	CB-A
.405" - .531"	COB A2	CC-A2	CB-A
.524" - .649"	COB B1	CC-B1	CB-B
.642" - .768"	COB B2	CC-B2	CB-B
.759" - .886"	COB C1	CC-C1	CB-C
.878" - 1.004"	COB C2	CC-C2	CB-C
.996" - 1.122"	COB D1	CC-D1	CB-D
1.114" - 1.161"	COB D2	CC-D2	CB-D